



PCB MOUNT RIBBON CONNECTORS

CENTURY INTERCONNECT PRODUCTS

Distributed by Electro-Stock, Inc. sales@electrostock.com
630-682-1542 Fax 630-682-1562 http://www.electrostock.com

RIGHT ANGLE PCB-C1R SERIES

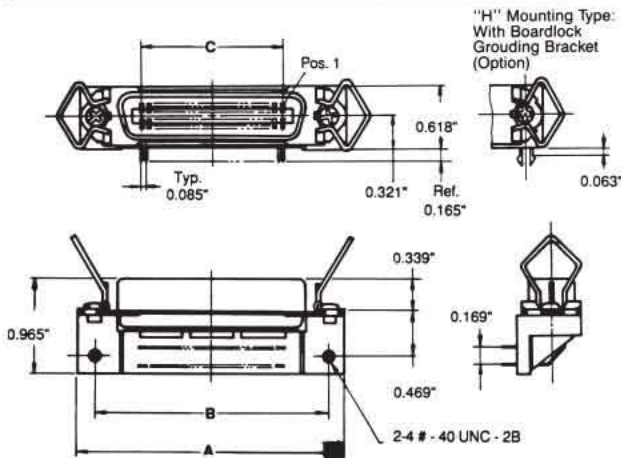
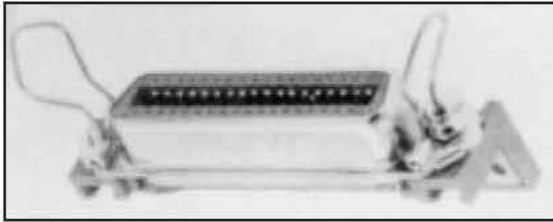

ORDERING INFORMATION

C1R 40 360 M H
1 2 3 4 5

1...Series

C1R...P.C.B. right angle mounting type ribbon contact connector

2...Contact & Connecting Types

10...Plug, without spring latch
20...Receptacle, without spring latch
40...Receptacle, with spring latch

3...Number of Contacts

140...14 Contacts,
240...24 Contacts,
360...36 Contacts,
500...50 Contacts

4...Housing Construction Types

M...With metal front shell

5...Mounting Types

H...With board lock grounding bracket
T...With #4.40UNC grounding bracket

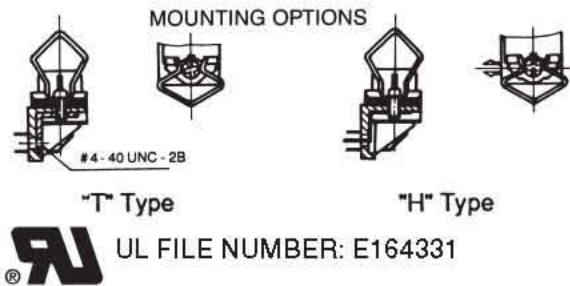

STRAIGHT PCB-C2R SERIES

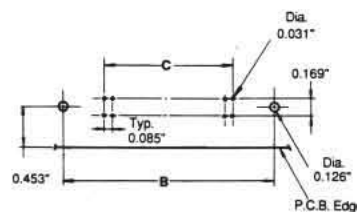
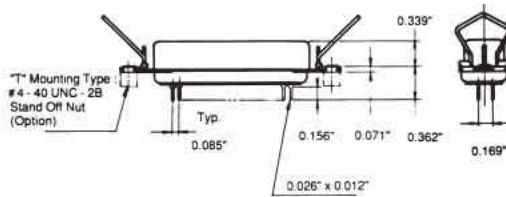
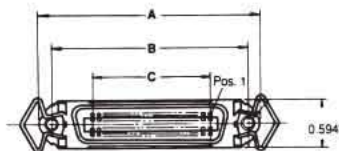
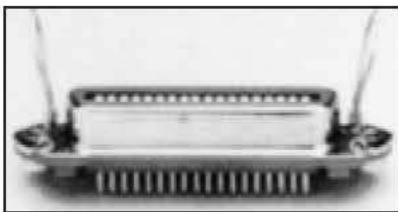

Recommended P.C.B. Layout

Number of Contacts	A	B	C
14	1.750	1.417	0.510
24	2.175	1.842	0.935
36	2.685	2.352	1.446
50	3.280	2.947	2.041

MOUNTING OPTIONS

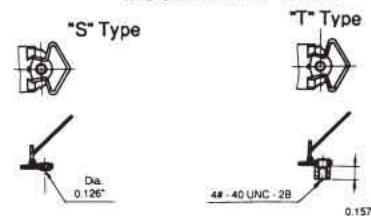

SPECIFICATIONS

ELECTRICAL:

Current Rating: 3 amps
Dielectric Withstanding Voltage: AC 1200 V min. for 1 minute
Insulation Resistance: 1000 MΩ min. at 500 V DC
Contact Resistance: 1000 mΩ max. mated
Operating Temperature: -55° C to +105° C

MECHANICAL:

Insulator Material: Blue polyester resin and glass fiber reinforced UL94V-0
Contact Material: Phosphor bronze
Contact Finish: Gold over nickel
Soldertail Finish: Tin-Lead over nickel

ORDERING INFORMATION

C2R 40 360 M S
1 2 3 4 5

1...Series

C2R...P.C.B. straight mounting type ribbon contact connector

2...Contact & Connecting Types

10...Plug, without spring latch
20...Receptacle, without spring latch
40...Receptacle, with spring latch

3...Number of Contacts

140...14 Contacts, 240...24 Contacts,
360...36 Contacts, 500...50 Contacts

4...Housing Construction Types

M...With metal front shell

5...Mounting Types

S...Standard through holes
T...With #4.40UNC stand off nut

Consult factory for plating options

UL FILE NUMBER: E164331