

6

5

4

3

2

1

MATERIAL AND FINISH

Insulator: Impact resistance Polypropylene, black, UL-94V-HB rated  
 PDSN-20A (wire leads): PVC, 26 AWG  
 Contact & terminals:  
 PDSN-20B: Brass, Nickel plated  
 PDSN-20C: Brass, Nickel plated

Spring: Spring Steel, Nickel plated imbedded in Polypropylene

ENVIRONMENTAL:  
 Operating temperature: -5°C to +83°C

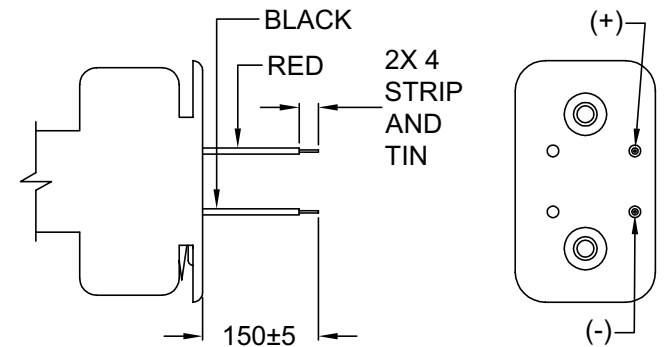

PDSN-20A WIRE LEADS

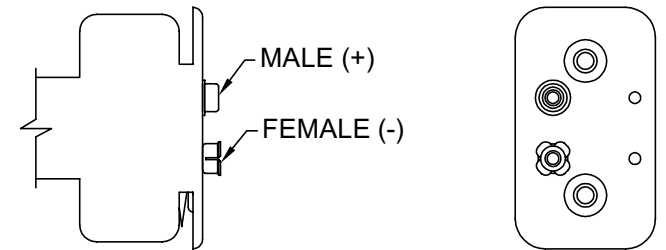

PDSN-20B SNAP TERMINAL

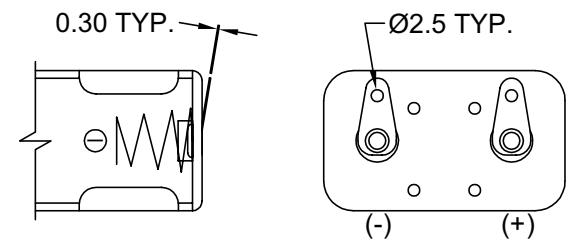

PDSN-20C SOLDER LUGS

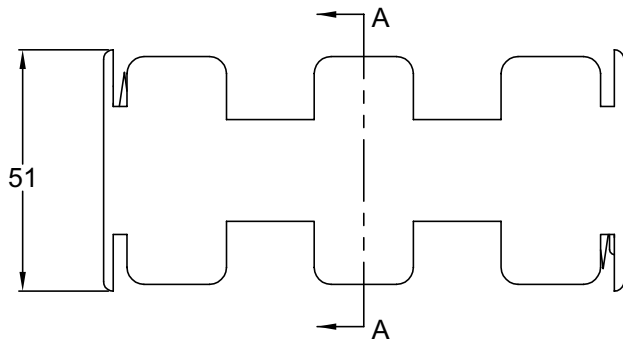

4X "C" BATTERIES

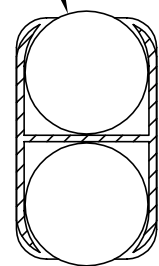

SECTION A-A

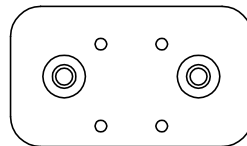
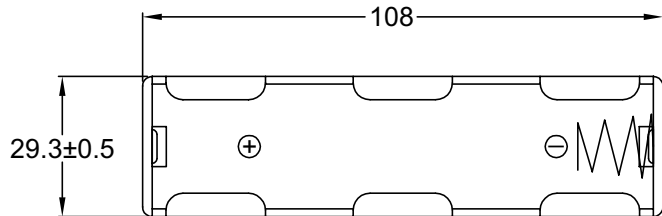

Distributed by Electro-Stock, Inc. sales@electrostock.com  
 630-682-1542 Fax 630-682-1562 http://www.electrostock.com

REVISIONS	CHNG	CHECK	APPR
	CHANGE		
REV	DATE		

TOLERANCE UNLESS OTHERWISE SPECIFIED		
X	±	1
X.X	±	0.4
X.XX	±	0.20
DRAWN BY	GQ	DATE: 05/10/02
CHECK BY	TD	DATE: 05/14/02
APPR BY	PB	DATE: 05/14/02

**Power Dynamics, Inc.**  
 Phone: 973 560-0019 Whippany, New Jersey Fax: 973 560-0076

PART: 4 CELL TYPE "C" BATTERY HOLDER  
 SIDE BY SIDE

**PDSN-20X**

SIZE: A  
 SCALE: NTS

ALL DIMENSIONS FOR REFERENCE ONLY  
 DIMENSIONS ARE IN MILLIMETERS

SHEET 1 of 1  
 REV:

6

5

4

3

2

1