



ROSE+BOPLA
ENCLOSURES

A PHOENIX MECANO COMPANY

BOTEGO Enclosures Product Drawings Last Updated 6/17/2008

Dimensional Drawings



TECHNICAL DATA:

- Color: Light gray, similar to RAL 7035. Special colors available on request, minimum order quantities apply.
- Material: ABS
- Ingress Protection: Closed IP 40 to EN 60529
With air vents: IP 30 to EN 60529
- Surface Resistance: $>10^{14}$ Ohm to DIN 53482.
- Disruptive Strength: 17KV/mm to DIN 53481
- Flammability: UL 94 HB/1.6.
- Note: Dimensions are external. Metric is the primary dimension. Inch conversions are for the user's convenience and are for reference only.



Cap set 4 is used to mount the BOTEGO enclosure to the wall. Light gray, similar to RAL 7035, in stock. Other colors available for cap sets: light green, graphite gray, dove blue, ultramarine and light blue. Minimum quantity order applies.

BOTEGO, Rose+Bopla's desktop enclosure system, sets new standards in enclosure technology. Thanks to its design, the enclosure consisting of two plastic half-shells can be inserted

BOTEGO

either horizontally or vertically. Extension sets permit optimal adaption to the relevant space requirements. In order to achieve natural ventilation everywhere in the enclosure, the system was developed so that sections with air vents can be mounted directly over each other or staggered.

With BOTEGO, every user can create their own individual design. Design elements and caps in 6 different colors are available and can modify the basic neutral enclosure to create an individual touch.

The basic BOTEGO enclosure consists of 2 half shells. Caps, front panels, and extension sets are accessories and must be ordered separately. Rose+Bopla offers color foils and customer specific foils for enclosure surface designs. Shape, color or embossing can be selected individually.

BOTEGO Enclosures

Model Number	Part Number	Width (Inches/mm)	Depth (Inches/mm)	Height (Inches/mm)	Weight lbs.	Drawing Page #
BO 32006	68320060	6.85 / 174.0	7.75 / 196.9	1.97 / 49.96	0.688	17-202
BO 32006 L	68320061	6.85 / 174.0	7.75 / 196.9	1.97 / 49.96	0.688	17-202
BO 32009	68320090	6.85 / 174.0	7.75 / 196.9	2.57 / 65.20	0.772	17-202
BO 32009 L	68320091	6.85 / 174.0	7.75 / 196.9	2.57 / 65.20	0.734	17-202
BO 32012	68320120	6.85 / 174.0	7.75 / 196.9	3.16 / 80.44	0.915	17-202
BO 32012 L	68320121	6.85 / 174.0	7.75 / 196.9	3.16 / 80.44	0.884	17-202
BO 51046	68514060	9.48 / 240.7	5.39 / 136.9	1.97 / 49.96	0.646	17-203
BO 51046 L	68514061	9.48 / 240.7	5.39 / 136.9	1.97 / 49.96	0.648	17-203
BO 51409	68214090	9.48 / 240.7	5.39 / 136.9	2.57 / 65.20	0.783	17-203
BO 51409 L	68514091	9.48 / 240.7	5.39 / 136.9	2.57 / 65.20	0.695	17-203
BO 51412	68514120	9.48 / 240.7	5.39 / 136.9	3.17 / 80.44	0.856	17-203
BO 51412 L	68514121	9.48 / 240.7	5.39 / 136.9	3.17 / 80.44	0.814	17-203
BO 52006	68520060	9.48 / 240.7	7.75 / 196.9	1.97 / 49.96	0.889	17-204
BO 52006 L	68520061	9.48 / 240.7	7.75 / 196.9	1.97 / 49.96	0.827	17-204
BO 52009	68520090	9.48 / 240.7	7.75 / 196.9	2.57 / 65.20	0.816	17-204
BO 52009 L	68520091	9.48 / 240.7	7.75 / 196.9	2.57 / 65.20	0.911	17-204
BO 52012	68520120	9.48 / 240.7	7.75 / 196.9	3.17 / 80.44	1.133	17-204
BO 52012 L	68520121	9.48 / 240.7	7.75 / 196.9	3.17 / 80.44	1.080	17-204
BO 62606	68626060	12.10 / 307.3	10.11 / 256.9	1.97 / 49.96	1.442	17-205
BO 62606 L	68626061	12.10 / 307.3	10.11 / 256.9	1.97 / 49.96	1.281	17-205
BO 62609	68626090	12.10 / 307.3	10.11 / 256.9	2.57 / 65.20	1.552	17-205
BO 62609 L	68626091	12.10 / 307.3	10.11 / 256.9	2.57 / 65.20	1.378	17-205
BO 62612	68626120	12.10 / 307.3	10.11 / 256.9	3.17 / 80.44	1.660	17-205
BO 62612 L	68626121	12.10 / 307.3	10.11 / 256.9	3.17 / 80.44	1.599	17-205

L=with molded-in air vents in lid and base

The usable basic enclosure height can be increased by using extension sets (BO AB). Front panels must be chosen based on the selected enclosure width.

Accessories shown on drawing page.

BOTEGO 320 Components

BOTEGO Enclosures, BO 320.. (L)						
Model Number	Part Number	Width (Inches/mm)	Height (Inches/mm)	Depth (Inches/mm)	Weight lbs.	Drawing Page #
BO 32006	68320060	6.85 / 174	7.75 / 196.9	1.97 / 49.96	0.688	17-202
BO 32006(L)	68320061	6.85 / 174	7.75 / 196.9	1.97 / 49.96	0.688	17-202
BO 32009	68320090	6.85 / 174	7.75 / 196.9	2.57 / 65.20	0.772	17-202
BO 32009(L)	68320091	6.85 / 174	7.75 / 196.9	2.57 / 65.20	0.734	17-202
BO 32012	68320120	6.85 / 174	7.75 / 196.9	3.16 / 80.44	0.915	17-202
BO 32012(L)	68320121	6.85 / 174	7.75 / 196.9	3.16 / 80.44	0.884	17-202

L=with molded-in air vents in lid and base

The BOTEGO enclosure BO 320... is offered in 3 different enclosure heights. The usable basic enclosure height can be increased by using extension sets, BO AB 02009...(L) according to the chart below.

Front panels BO FP ..., must be chosen based on the selected enclosure width.

Including: Two half-shells.

Accessories shown on drawing page.

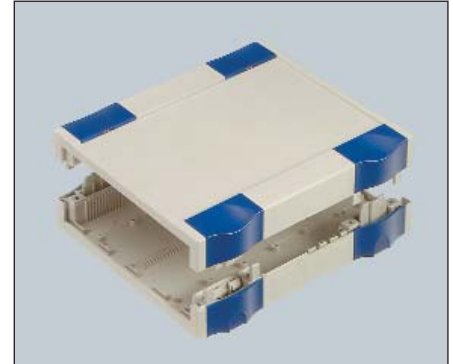

BOTEGO, BO 320..., without air vents

BO 320..(L) Selection Table For Front Panels and Extension Sets						
Model Number	Usable Enclosure Height Inches/mm	TE	Number of BO AB 02009 (L)	Front Panels To Be Used	Model Number	Drawing Page #
BO 32006 (L)	1.23 / 31.28	6	-	BO FP 30006	68711306	17-202
BO 32009 (L)	1.83 / 46.52	9	-	BO FP 30009	68711309	17-202
BO 32012 (L)	2.43 / 61.76	12	-	BO FP 30012	68711312	17-202
BO 32006 (L)	3.03 / 77.00	15	1	BO FP 30015	68711315	17-202
BO 32009 (L)	3.63 / 92.24	18	1	BO FP 30018	68711318	17-202
BO 32012 (L)	4.23 / 107.48	21	1	BO FP 30021	68711321	17-202
BO 32006 (L)	4.83 / 122.72	24	2	BO FP 30024	68711324	17-202
BO 32009 (L)	5.43 / 137.96	27	2	BO FP 30027	68711327	17-202
BO 32012 (L)	6.03 / 153.20	30	2	BO FP 30030	68711330	17-202
BO 32006 (L)	6.63 / 168.44	33	3	BO FP 30033	68711333	17-202
BO 32009 (L)	7.23 / 183.68	36	3	BO FP 30036	68711336	17-202
BO 32012 (L)	7.83 / 198.92	39	3	BO FP 30039	68711339	17-202
BO 32006 (L)	8.43 / 214.16	42	4	BO FP 30042	68711342	17-202
BO 32009 (L)	9.03 / 229.40	45	4	BO FP 30045	68711345	17-202
BO 32012 (L)	9.63 / 244.64	48	4	BO FP 30048	68711348	17-202

Charts for Extension sets and Front panels shown on page 5-50.



BOTEGO, BO 320..L, with air vents

Note: Dimensions are external. Metric is the primary dimension. Inch conversions are for the user's convenience and are for reference only.

BOTEGO 320 Components



Botego 320.. L front panels.

BOTEGO Plug-in Front Panels BO FP... For BO 320..(L)					
Model Number	Part Number	TE	Height (Inches/mm)	Width (Inches/mm)	Weight lbs.
BO FP 30006	68711306	6	1.67 / 42.48	6.34 / 161	0.079
BO FP 30009	68711309	9	2.27 / 57.75	6.34 / 161	0.108
BO FP 30012	68711312	12	2.87 / 72.96	6.34 / 161	0.137
BO FP 30015	68711315	15	3.47 / 88.20	6.34 / 161	0.165
BO FP 30018	68711318	18	4.07 / 103.44	6.34 / 161	0.194
BO FP 30021	68711321	21	4.67 / 118.68	6.34 / 161	0.223
BO FP 30024	68711324	24	5.27 / 133.92	6.34 / 161	0.251
BO FP 30027	68711327	27	5.87 / 149.16	6.34 / 161	0.280
BO FP 30030	68711330	30	6.47 / 164.40	6.34 / 161	0.309
BO FP 30033	68711333	33	7.07 / 179.64	6.34 / 161	0.337
BO FP 30036	68711336	36	7.67 / 194.88	6.34 / 161	0.336
BO FP 30039	68711339	39	8.27 / 210.12	6.34 / 161	0.395
BO FP 30042	68711342	42	8.87 / 225.35	6.34 / 161	0.423
BO FP 30045	68711345	45	9.47 / 240.60	6.34 / 161	0.452
BO FP 30048	68711348	48	10.07 / 255.84	6.34 / 161	0.481

FP=Anodized aluminum, 2.0mm thick

Front panels must be chosen to match the selected extension sets. Please refer to selection table on page 5-49.

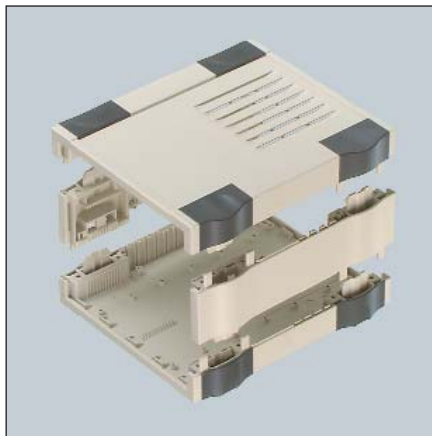

Botego 320.. L with extension set.

BOTEGO Extension Sets BO AB... For BO 320.. (L)				
Model Number	Part Number	Color	Drawing Page #	Weight lbs.
BO AB 02009-7035	68200910	Light gray, similar to RAL 7035	17-202	0.216
BO AB 02009 L-7035	68200911	Light gray, similar to RAL 7035	17-202	0.196

L = with molded-in air vents in lid and base

Extension Sets make it possible to extend the BOTEGO enclosure between the half shells.

Including: Two extension units.

Other colors available, call for details. Minimum quantity order applies.

Note: Dimensions are external. Metric is the primary dimension. Inch conversions are for the user's convenience and are for reference only.

BOTEGO 514 Components

BOTEGO Enclosures, BO 514.. (L)						
Model Number	Part Number	Width (Inches/mm)	Height (Inches/mm)	Depth (Inches/mm)	Weight lbs.	Drawing Page #
BO 51406	68514060	9.48 / 240.7	1.97 / 49.96	5.39 / 136.9	0.646	17-203
BO 51406 (L)	68514061	9.48 / 240.7	1.97 / 49.96	5.39 / 136.9	0.648	17-203
BO 51409	68514090	9.48 / 240.7	2.57 / 65.20	5.39 / 136.9	0.783	17-203
BO 51409 (L)	68514091	9.48 / 240.7	2.57 / 65.20	5.39 / 136.9	0.695	17-203
BO 51412	68514120	9.48 / 240.7	3.17 / 80.44	5.39 / 136.9	0.856	17-203
BO 51412 (L)	68514121	9.48 / 240.7	3.17 / 80.44	5.39 / 136.9	0.814	17-203

L=with molded-in air vents in lid and base

Front panels must be chosen based on the selected enclosure width.

Including: Two half-shells.

Accessories shown on drawing page.

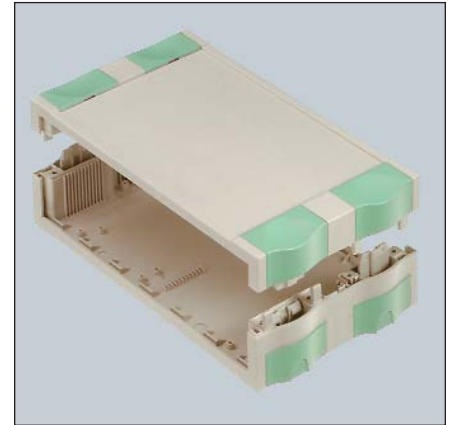

BOTEGO, BO 514..., without air vents

BO 514 Selection Table For Aluminum Front Panels						
Model Number	Part Number	TE	Height Inches/mm	Width Inches/mm	Weight lbs.	Suitable for Enclosure
BO FP 50006	68711506	6	1.67 / 42.48	8.96 / 227.65	0.112	BO 51406 (L)
BO FP 50009	68711509	9	2.27 / 57.72	8.96 / 227.65	0.152	BO 51409 (L)
BO FP 50012	68711512	12	2.87 / 72.96	8.96 / 227.65	0.194	BO 51412 (L)

FP = Anodized aluminum, 2mm thick.

Aluminum front panels for insertion in enclosure half-shells. On request we can supply these machined, painted, or silk-screened.

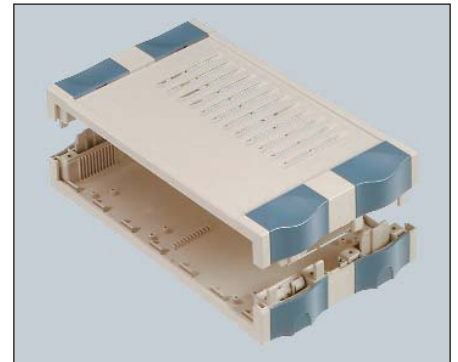

BOTEGO, BO 514..L, with air vents

Note: Dimensions are external. Metric is the primary dimension. Inch conversions are for the user's convenience and are for reference only.

BOTEGO 520 Components

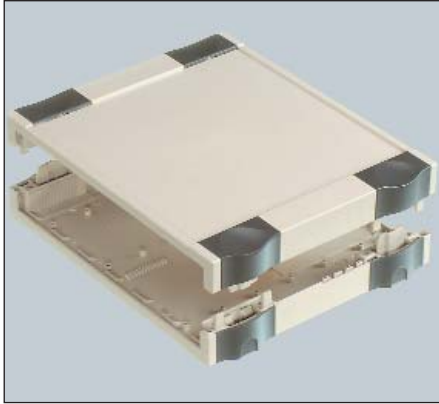

BOTEGO, BO 520.., without air vents

BOTEGO Enclosures, BO 520.. (L)						
Model Number	Part Number	Width (Inches/mm)	Height (Inches/mm)	Depth (Inches/mm)	Weight lbs.	Drawing Page #
BO 52006	68520060	9.48 / 240.7	1.97 / 49.96	7.75 / 196.9	0.889	17-204
BO 52006 L	68520061	9.48 / 240.7	1.97 / 49.96	7.75 / 196.9	0.827	17-204
BO 52009	68520090	9.48 / 240.7	2.57 / 65.20	7.75 / 196.9	0.816	17-204
BO 52009 L	68520091	9.48 / 240.7	2.57 / 65.20	7.75 / 196.9	0.911	17-204
BO 52012	68520120	9.48 / 240.7	3.17 / 80.44	7.75 / 196.9	1.133	17-204
BO 52012 L	68520121	9.48 / 240.7	3.17 / 80.44	7.75 / 196.9	1.080	17-204

L=with molded-in air vents in lid and base

The Botego enclosure, BO520... is offered in 3 different enclosure heights. The usable basic enclosure height can be increased by using extension sets, BO AB-02009(L), according to the chart below.

Front panels, BO FP..., must be chosen based on the selected enclosure width.

Including: Two half-shells.

Accessories shown on drawing page.

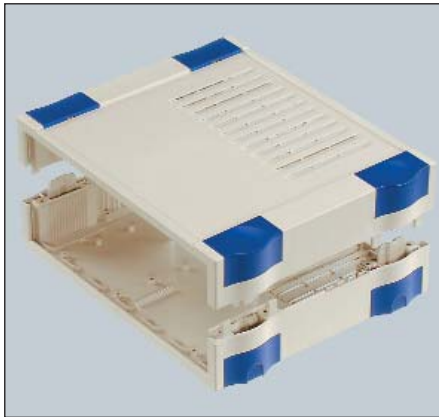

BOTEGO, BO 520..L, with air vents

BO 520..(L) Selection Table For Front Panels and Extension Sets						
Model Number	Usable Enclosure Height Inches/mm	TE	Number of BO AB 02009 (L)	Front Panels To Be Used	Part Number	Drawing Page #
BO 52006 (L)	1.23 / 31.28	6	–	BO FP 50006	58711506	17-204
BO 52009 (L)	1.83 / 46.52	9	–	BO FP 50009	68711509	17-204
BO 52012 (L)	2.43 / 61.76	12	–	BO FP 50012	68711512	17-204
BO 52006 (L)	3.03 / 77.00	15	1	BO FP 50015	68711515	17-204
BO 52009 (L)	3.63 / 92.24	18	1	BO FP 50018	68711518	17-204
BO 52012 (L)	4.23 / 107.48	21	1	BO FP 50021	68711521	17-204
BO 52006 (L)	4.83 / 122.72	24	2	BO FP 50024	68711524	17-204
BO 52009 (L)	5.43 / 137.96	27	2	BO FP 50027	68711527	17-204
BO 52012 (L)	6.03 / 153.20	30	2	BO FP 50030	68711530	17-204
BO 52006 (L)	6.63 / 168.44	33	3	BO FP 50033	68711533	17-204
BO 52009 (L)	7.23 / 183.68	36	3	BO FP 50036	68711536	17-204
BO 52012 (L)	7.83 / 198.92	39	3	BO FP 50039	68711539	17-204
BO 52006 (L)	8.43 / 214.16	42	4	BO FP 50042	68711542	17-204
BO 52009 (L)	9.03 / 229.40	45	4	BO FP 50045	68711545	17-204
BO 52012 (L)	9.63 / 244.64	48	4	BO FP 50048	68711548	17-204

Charts for extension sets and front panels shown on page 5-53.

Note: Dimensions are external. Metric is the primary dimension. Inch conversions are for the user's convenience and are for reference only.

BOTEGO 520 Components

BOTEGO Plug-in Front Panels For BO 520..(L)					
Model Number	Part Number	TE	Height (Inches/mm)	Width (Inches/mm)	Weight lbs.
BO FP 50006	68711506	6	1.67 / 42.48	8.96 / 227.65	.112
BO FP 50009	68711509	9	2.27 / 57.72	8.96 / 227.65	.152
BO FP 50012	68711512	12	2.87 / 72.96	8.96 / 227.65	.194
BO FP 50015	68711515	15	3.47 / 88.20	8.96 / 227.65	.234
BO FP 50018	68711518	18	4.07 / 103.44	8.96 / 227.65	.276
BO FP 50021	68711521	21	4.67 / 118.68	8.96 / 227.65	.315
BO FP 50024	68711524	24	5.27 / 133.92	8.96 / 227.65	.355
BO FP 50027	68711527	27	5.87 / 149.16	8.96 / 227.65	.397
BO FP 50030	68711530	30	6.47 / 164.40	8.96 / 227.65	.437
BO FP 50033	68711533	33	7.07 / 179.64	8.96 / 227.65	.476
BO FP 50036	68711536	36	7.67 / 194.88	8.96 / 227.65	.518
BO FP 50039	68711539	39	8.27 / 210.12	8.96 / 227.65	.558
BO FP 50042	68711542	42	8.87 / 225.36	8.96 / 227.65	.644
BO FP 50045	68711545	45	9.47 / 240.60	8.96 / 227.65	.684
BO FP 50048	68711548	48	10.07 / 255.84	8.96 / 227.65	.679

FP=Anodized aluminum, 2.0mm thick

Front panels must be chosen to match the selected extension sets. Please refer to selection table on page 5-52.

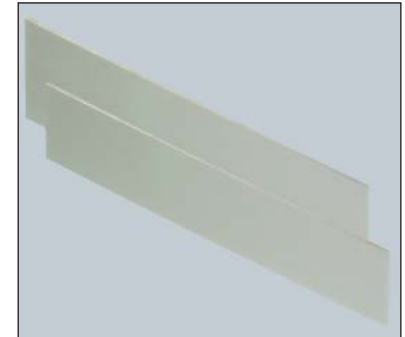

Botego 520..L front panels

BOTEGO Extension Sets, BO AB..., For BO 520.. (L)				
Model Number	Part Number	Color	Weight lbs.	Drawing Page #
BO AB 02009-7035	68200910	Light gray, similar to RAL 7035	.216	17-204
BO AB 02009 L-7035	68200911	Light gray, similar to RAL 7035	.196	17-204

L = with molded-in air vents in lid and base

Extension Sets make it possible to extend the BOTEGO enclosure between the half shells.

Including: Two extension units.

Additional colors available. Call for details. Minimum quantity order applies.

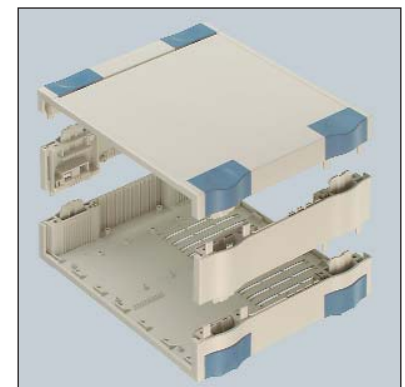

Botego 520..L with extension set.

Note: Dimensions are external. Metric is the primary dimension. Inch conversions are for the user's convenience and are for reference only.

BOTEGO 626 Components



BOTEGO, BO 626..., without air vents

BOTEGO Enclosures, BO 626.. (L)						
Model Number	Part Number	Width (Inches/mm)	Height (Inches/mm)	Depth (Inches/mm)	Weight lbs.	Drawing Page #
BO 62606	68626060	12.10 / 307.35	1.97 / 49.96	10.11 / 256.9	1.442	17-205
BO 62606 L	68626061	12.10 / 307.35	1.97 / 49.96	10.11 / 256.9	1.281	17-205
BO 62609	68626090	12.10 / 307.35	2.57 / 65.20	10.11 / 256.9	1.552	17-205
BO 62609 L	68626091	12.10 / 307.35	2.57 / 65.20	10.11 / 256.9	1.378	17-205
BO 62612	68626120	12.10 / 307.35	3.17 / 80.44	10.11 / 256.9	1.660	17-205
BO 62612 L	68626121	12.10 / 307.35	3.17 / 80.44	10.11 / 256.9	1.599	17-205

L=with molded-in air vents in lid and base

The BOTEGO enclosure, BO 626..., is offered in 3 different heights. The usable basic enclosure height can be increased by using extension sets, BO AB-02609...(L), according to the chart below. Front panels BO FP..., must be chosen based on the selected enclosure width.

Including: Two half-shells.

Accessories shown on drawing page.

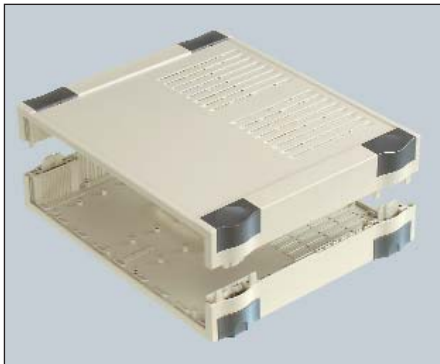

BOTEGO, BO 626..L, with air vents

BO 626..(L) Selection Table For Front Panels and Extension Sets						
Model Number	Usable Enclosure Height Inches/mm	TE	Number of BO AB 02009 (L)	Front Panels To Be Used	Part Number	Drawing Page #
BO 62606 (L)	1.23 / 31.28	6	-	BO FP 60006	68711606	17-205
BO 62609 (L)	1.83 / 46.52	9	-	BO FP 60009	68711609	17-205
BO 62612 (L)	2.43 / 61.76	12	-	BO FP 60012	68711612	17-205
BO 62606 (L)	3.03 / 77.00	15	1	BO FP 60015	68711615	17-205
BO 62609 (L)	3.63 / 92.24	18	1	BO FP 60018	68711618	17-205
BO 62612 (L)	4.23 / 107.48	21	1	BO FP 60021	68711621	17-205
BO 62606 (L)	4.83 / 122.72	24	2	BO FP 60024	68711624	17-205
BO 62609 (L)	5.43 / 137.96	27	2	BO FP 60027	68711627	17-205
BO 62612 (L)	6.03 / 153.20	30	2	BO FP 60030	68711630	17-205
BO 62606 (L)	6.63 / 168.44	33	3	BO FP 60033	68711633	17-205
BO 62609 (L)	7.23 / 183.68	36	3	BO FP 60036	68711636	17-205
BO 62612 (L)	7.83 / 198.92	39	3	BO FP 60039	68711639	17-205
BO 62606 (L)	8.43 / 214.16	42	4	BO FP 60042	68711642	17-205
BO 62609 (L)	9.03 / 229.40	45	4	BO FP 60045	68711645	17-205
BO 62612 (L)	9.63 / 244.64	48	4	BO FP 60048	68711648	17-205

Charts for extension sets and front panels shown on page 5-55.

Note: Dimensions are external. Metric is the primary dimension. Inch conversions are for the user's convenience and are for reference only.

BOTEGO 626 Components

BOTEGO Plug-in Front Panels, BO FP..., For BO 626..(L)					
Model Number	Part Number	TE	Height (Inches/mm)	Width (Inches/mm)	Weight lbs.
BO FP 60006	68711606	6	1.67 / 42.48	11.59 / 294.35	1.455
BO FP 60009	68711609	9	2.27 / 57.72	11.59 / 294.35	.198
BO FP 60012	68711612	12	2.87 / 72.96	11.59 / 294.35	.251
BO FP 60015	68711615	15	3.47 / 88.20	11.59 / 294.35	.302
BO FP 60018	68711518	18	4.07 / 103.44	11.59 / 294.35	.355
BO FP 60021	38711621	21	4.67 / 118.68	11.59 / 294.35	.406
BO FP 60024	68711624	24	5.27 / 133.92	11.59 / 294.35	.492
BO FP 60027	68711627	27	5.87 / 149.16	11.59 / 294.35	.540
BO FP 60030	68711630	30	6.47 / 164.40	11.59 / 294.35	.595
BO FP 60033	68711633	33	7.07 / 179.64	11.59 / 294.35	.650
BO FP 60036	68711636	36	7.67 / 194.88	11.59 / 294.35	.668
BO FP 60039	68711639	39	8.27 / 210.12	11.59 / 294.35	.721
BO FP 60042	68711642	42	8.87 / 225.30	11.59 / 294.35	.822
BO FP 60045	68711645	45	9.47 / 240.60	11.59 / 294.35	.827
BO FP 60048	68711648	48	10.07 / 255.84	11.59 / 294.35	.878

FP=Anodized aluminum, 2.0mm thick

Front panels must be chosen to match the selected extension sets. Please refer to selection table on page 5-54.

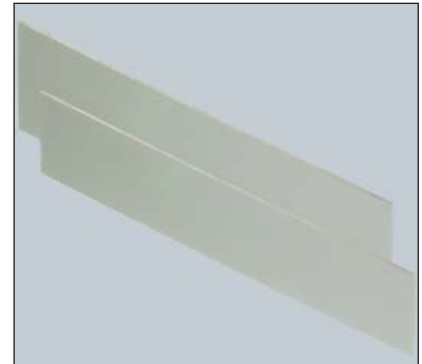

Botego 620..front panels.

BOTEGO Extension Sets BO AB... For BO 626.. (L)				
Model Number	Part Number	Color	Weight lbs.	Drawing Page #
BO AB 02009-7035	68260910	Light gray, similar to RAL 7035	0.216	17-205
BO AB 02009 L-7035	68260911	Light gray, similar to RAL 7035	0.196	17-205

L = with molded-in air vents in lid and base

Extension Sets make it possible to extend the BOTEGO enclosure between the half shells.

Including: Two extension units.

Other colors available. Call for details. Minimum quantity order applies.

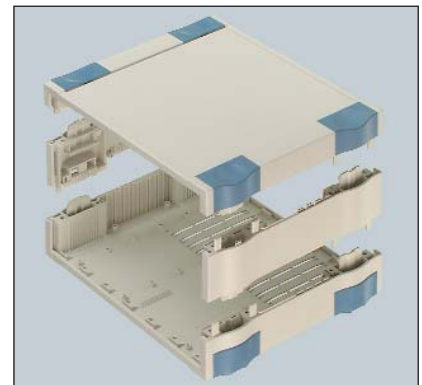

Botego 520..L with extension set.

Note: Dimensions are external. Metric is the primary dimension. Inch conversions are for the user's convenience and are for reference only.

Standard Features

Modular ABS enclosure system, light gray, similar to RAL 7035. Includes two half shells. The usable enclosure height can be increased by use of extension sets BO AB 02009-..., listed on page 5-50. Front panels must be chosen based on the selected enclosure width.

- **BO 32006/68320090**
- **BO 32006 L/68320061** With molded-in air vents.
- **BO 32009/68320090**
- **BO 32009 L/68320091** With molded-in air vents.
- **BO 32012/68320120**
- **BO 32012 L/68320121** With molded-in air vents

Accessories

- **BO-KS 1-7035/68011000** Cap set 1, light gray, similar to RAL 7035. Designed for use with desktop enclosures.
- **BO-KS 2-7035/38021000** Cap set 2, light gray, similar to RAL 7035. Allows stacking of enclosures and air circulation for air vent versions.
- **BO-KS 3-7035/68031000** Cap set 3, light gray, similar to RAL 7035. Suitable for stand alone enclosures. Collapsible feet can be used to tilt the enclosure.
- **BO-KS 4-7035/68041000** Cap set 4, light gray, similar to RAL 7035. Suitable for mounting the enclosure to the wall.
- **BO DI-9 TE-7035/68110910** Design element 1, light gray similar to RAL 7035
- **BO D2-6 TE-7035/68120610** Design element 2, light gray, similar to RAL 7035
- **BO D3-6 TE-7035/38130610** Design element 3, light gray, similar to RAL 7035
- **BO D4-9 TE-7035/68140910** Design element 4, light gray, similar to RAL 7035
- **BO FF1-32000/70681320** Design foil 1
- **BO FF2-32000/70650.00** Design foil 2
- **BO BP1-21/68731210** Filling profile set for mounting racks
- **BO SF-3001800/68018003** Angled Operating Front, TE 18
- **BO FP 30006 /68711306** Front panel, anodized aluminum 2mm thick, TE 6.
- **BO FP 30009/68711309** Front panel, anodized aluminum* 2mm thick, TE 9.
- **BO FP 30012/68711312** Front panel, anodized aluminum* 2mm thick, TE 12.
- **BO FP 30015/68711315** Front panel, anodized aluminum* 2mm thick, TE 15.
- **BO FP 30018/68711318** Front panel, anodized aluminum* 2mm thick, TE 18.
- **BO FP 30021/68711321** Front panel, anodized aluminum* 2mm thick, TE 21.
- **BO FP 30024/38711324** Front panel, anodized aluminum* 2mm thick, TE 24.
- **BO FP 30027/68711327** Front panel, anodized aluminum* 2mm thick, TE 27.
- **BO FP 30030/68711330** Front panel, anodized aluminum* 2mm thick, TE 27.
- **BO FP 30033/68711333** Front panel, anodized aluminum* 2mm thick, TE 33.
- **BO FP 30036/68711336** Front panel, anodized aluminum* 2mm thick, TE 36.
- **BO FP 30039/68711339** Front panel, anodized aluminum* 2mm thick, TE 39.
- **BO FP 30042/68711342** Front panel, anodized aluminum* 2mm thick, TE 42.
- **BO FP 30045/68711345** Front panel, anodized aluminum* 2mm thick, TE 45.
- **BO FP 30048/68711348** Front panel, anodized aluminum* 2mm thick, TE 48.
- **BO AB 02009-7035/68200910** Extension set, light gray similar to RAL 7035.
- **BO AB 02009-7035 L/68200911** Extension set with ventilation, light gray similar to RAL 7035.
- **BO HS 30000/68430000** Handle
- **68900040** Botege Strain relief set
- **68900030** Screw set

*Note: For aluminum 2.5mm front anodized, rear yellow cromated front panels see page 17-206.

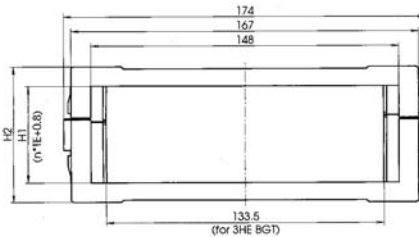
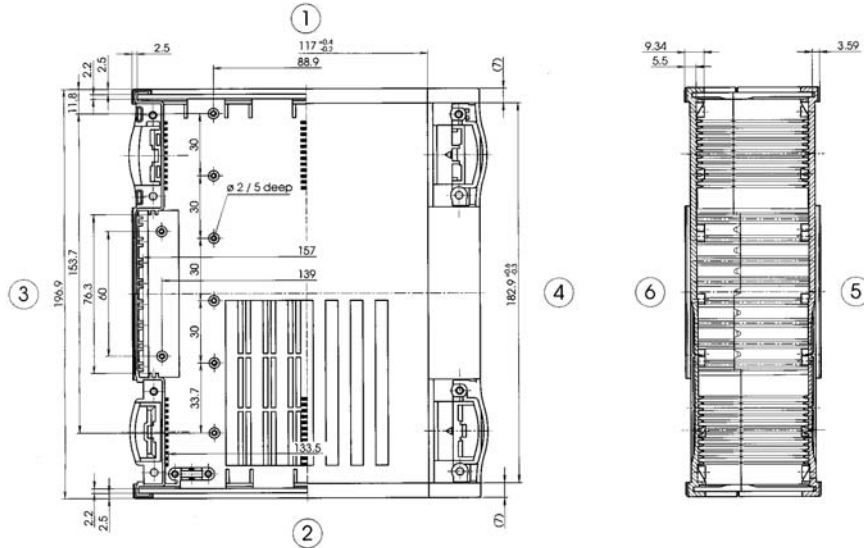

Part Number	H1	H2	n
BO 32006 (L)	31.28	49.96	6
BO 32009 (L)	46.52	65.20	9
BO 32012 (L)	61.76	80.44	12



BO 32006 / BO 32006 L
(half shell low/low)

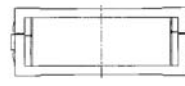

BO 32009 / BO 32009 L
(half shell low/high)



BO 32012 / BO 32012 L
(half shell high/high)

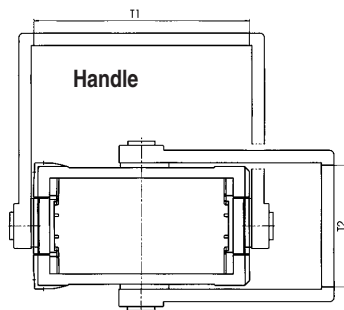

Part Number	TE	T1	T2
BO HS 30000	-	174.0	-

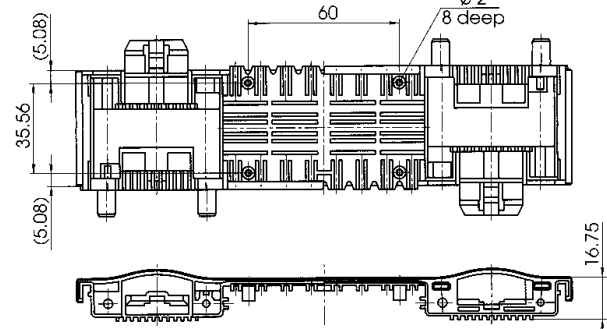

Extension set BO AB 02009-(L) ...



BO 514..(L)

External Dimensions: W 241 x H 50 x D 137 mm

Page 5-48, 51

Standard Features

Modular ABS enclosure system, light gray, similar to RAL 7035. Includes two half shells. Front panels must be chosen based on the selected enclosure width.

- **BO 51406/68514060**
- **BO 51406 L/68514061** With molded-in air vents.
- **BO 51409/68514090**
- **BO 51409 L/68514091** With molded-in air vents.
- **BO 51412/68514120**
- **BO 51412 L/68514121** With molded-in air vents

Accessories

- **BO-KS 1-7035/68011000** Cap set 1, light gray, similar to RAL 7035. Designed for use with desktop enclosures.
- **BO-KS 2-7035/38021000** Cap set 2, light gray, similar to RAL 7035. Allows stacking of enclosures and air circulation for air vent versions.
- **BO-KS 3-7035/68031000** Cap set 3, light gray, similar to RAL 7035. Suitable for stand alone enclosures. Collapsible feet can be used to tilt the enclosure.
- **BO-KS 4-7035/68041000** Cap set 4, light gray, similar to RAL 7035. Suitable for mounting the enclosure to the wall.
- **BO DI-9 TE-7035/68110910** Design element 1, light gray similar to RAL 7035
- **BO D2-6 TE-7035/6812610** Design element 2, light gray, similar to RAL 7035
- **BO D3-6 TE-7035/68130610** Design element 3, light gray, similar to RAL 7035
- **BO D4-9 TE-7035/68140910** Design element 4, light gray, similar to RAL 7035
- **BO FF1-51400/70681514** Design foil 1
- **BO FF2-51400/70682514** Design foil 2
- **BO FP 50006 */68711506** Front panel, anodized aluminum 2mm thick, TE 6.
- **BO FP 50009*/68711509** Front panel, anodized aluminum* 2mm thick, TE 9.
- **BO FP 50012*/68711512** Front panel, anodized aluminum* 2mm thick, TE 12.
- **BO HS 50000/68450000** Handle
- **68900040** Strain relief set
- **68900030** Screw set

*Note: For aluminum 2.5mm front anodized, rear yellow cromated front panels see page 17-206.

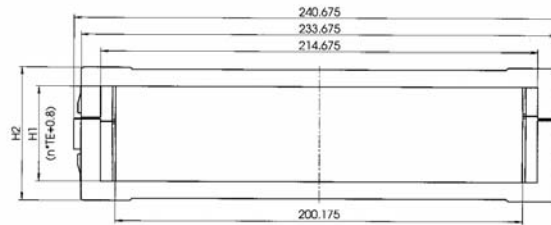
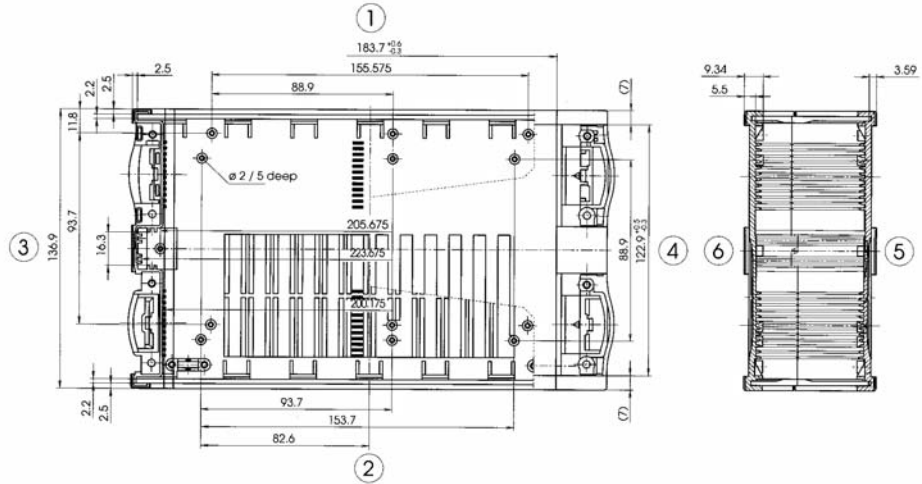

Part Number	H1	H2	n
BO 51406 (L)	31.28	49.96	6
BO 51409 (L)	46.52	65.20	9
BO 51412 (L)	61.76	80.44	12

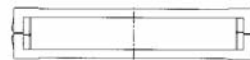

BO 51406 / BO 51406 L
(half shell low/low)

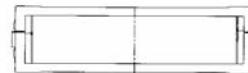

BO 51409 / BO 51409 L
(half shell low/high)

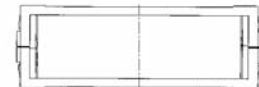

BO 51412 / BO 51412 L
(half shell high/high)

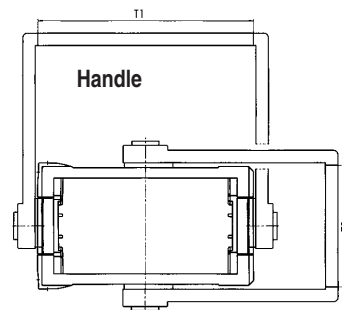

Part Number	TE	T1	T2
BO HS 50000	-	240.7	-

Dimensional Drawings



BO 626..(L)

External Dimensions: W 307 x H 50 x D 257 mm

Standard Features

Modular ABS enclosure system, light gray, similar to RAL 7035. Includes two half shells. The usable enclosure height can be increased by use of extension sets AB 02009-02609 (L)...., listed on page 5-55. Front panels must be chosen based on the selected enclosure width.

- BO 62606/68626060
- BO 62606 L/68626061 With molded-in air vents.
- BO 62609/68626090
- BO 62609 L/68626091 With molded-in air vents.
- BO 62612/68626120
- BO 62612 L/68626121 With molded-in air vents

Accessories

- BO-KS 1-7035/68011000 Cap set 1, light gray, similar to RAL 7035. Designed for use with desktop enclosures.
- BO-KS 2-7035/68021000 Cap set 2, light gray, similar to RAL 7035. Allows stacking of enclosures and air circulation for air vent versions.
- BO-KS 3-7035/68031000 Cap set 3, light gray, similar to RAL 7035. Suitable for stand alone enclosures. Collapsible feet can be used to tilt the enclosure.
- BO D1-9 TE-7035/68110910 Design element 1, light gray similar to RAL 7035
- BO D2-6 TE-7035/68120610 Design element 2, light gray, similar to RAL 7035
- BO D3-6 TE-7035/68130610 Design element 3, light gray, similar to RAL 7035
- BO D4-9 TE-7035/68140910 Design element 4, light gray, similar to RAL 7035
- BO FF1-62600/70681626 Design foil 1
- BO FF2-62600/70682626 Design foil 2
- BO BP1-42/68731420 Filling profile set for mounting racks
- BO AB 02609-7035/68260910 Light gray extension set with vents (2 pieces)
- BO FP 60006*/68711606 Front panel, anodized aluminum 2mm thick, TE 6.
- BO FP 60009*/68711609 Front panel, anodized aluminum* 2mm thick, TE 9.
- BO FP 60012*/68711612 Front panel, anodized aluminum* 2mm thick, TE 12.
- BO FP 60015*/68711615 Front panel, anodized aluminum* 2mm thick, TE 15.
- BO FP 60018*/68711618 Front panel, anodized aluminum* 2mm thick, TE 18.
- BO FP 60021*/68711621 Front panel, anodized aluminum* 2mm thick, TE 21.
- BO FP 60024*/68711624 Front panel, anodized aluminum* 2mm thick, TE 24.
- BO FP 60027*/68711627 Front panel, anodized aluminum* 2mm thick, TE 27.
- BO FP 60030*/68711630 Front panel, anodized aluminum* 2mm thick, TE 27.
- BO FP 60033*/68711633 Front panel, anodized aluminum* 2mm thick, TE 33.
- BO FP 60036*/68711636 Front panel, anodized aluminum* 2mm thick, TE 36.
- BO FP 60039*/68711639 Front panel, anodized aluminum* 2mm thick, TE 39.
- BO FP 60042*/68711642 Front panel, anodized aluminum* 2mm thick, TE 42.
- BO FP 60045*/68711645 Front panel, anodized aluminum* 2mm thick, TE 45.
- BO FP 60048*/68711648 Front, panel, anodized aluminum* 2mm thick, TE 48.
- BO AB 02009-7035/68200910 Extension set, light gray similar to RAL 7035. (2 pieces)
- BO AB 02009-7035 L/68200911 Extension set with ventilation, light gray similar to RAL 7035. (2 pieces)
- BO HS 5000/68450000 Handle
- 68900040 Botego Strain relief set
- 68900030 Screw set

*Note: For aluminum 2.5mm front anodized, rear yellow cromated front panels see page 17-206.

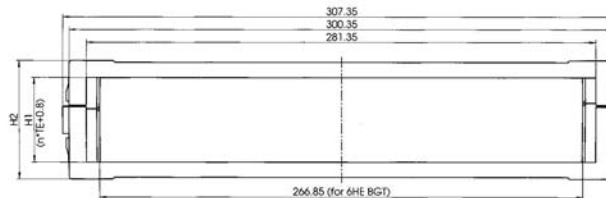
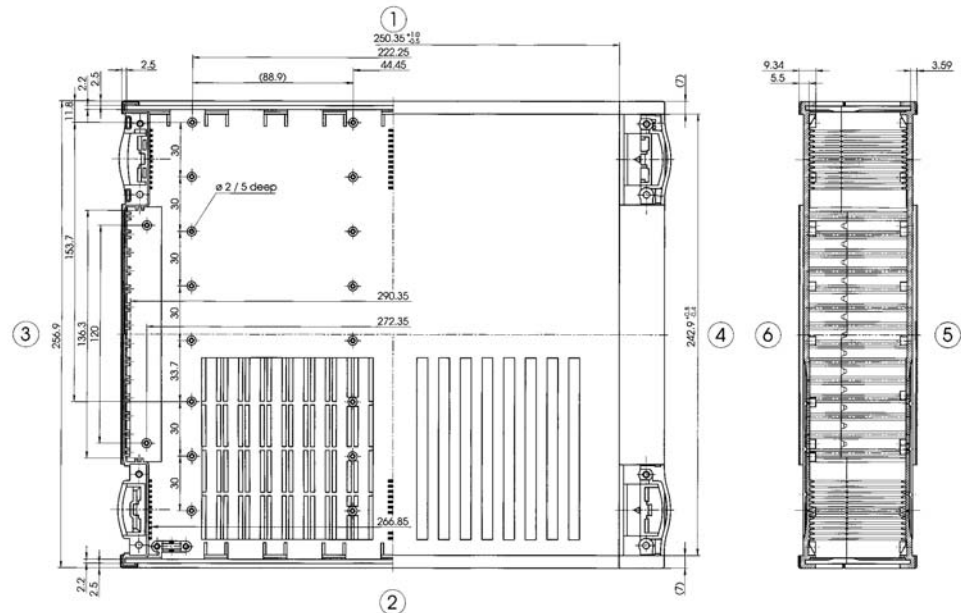

Part Number	H1	H2	n
BO 62606 (L)	31.28	49.96	6
BO 62609 (L)	46.52	65.20	9
BO 62612 (L)	61.76	80.44	12

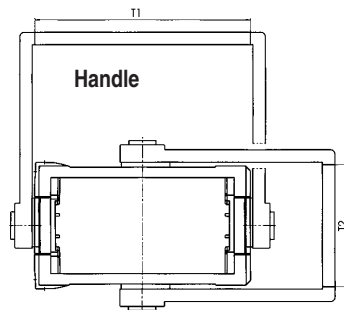
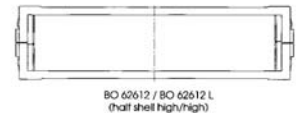
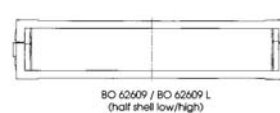
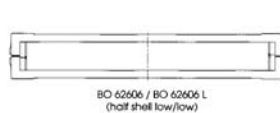

Part Number	TE	T1	T2
BO HS 60000	-	307.4	-

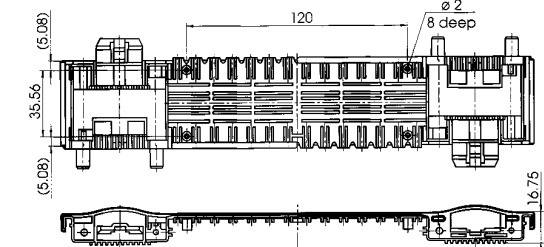

Extension set BO AB 02609-(L)

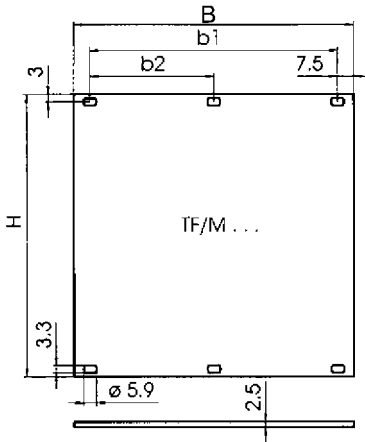

Material: aluminum 2.5mm front anodized, rear yellow chromated. Part front panels from 6 to 48 TE. For 3, 4, 5, and 6 HE. Front panels must be chosen to match selected enclosure width.

Model Number	Part Number	HE	Height Inches/mm	TE	B Inches/mm	b1 Inches/mm	b2 Inches/mm
TF/M 306	86806033	3	5.05 /128.4	6	1.18/ 30.1	-	-
TF/M 309	86809033	3	5.05 /128.4	9	1.79/ 45.4	-	-
TF/M 312	86812033	3	5.05 /128.4	12	2.38/ 60.6	1.80/ 45.7	-
TF/M 315	86815033	3	5.05 /128.4	15	2.98/ 75.8	2.40/ 61.0	-
TF/M 318	86818033	3	5.05 /128.4	18	3.58/ 91.0	3.00/ 76.2	-
TF/M 321	86821033	3	5.05 /128.4	21	4.18/106.3	3.60/ 91.4	-
TF/M 324	86824033	3	5.05 /128.4	24	4.78/121.5	4.20/106.7	-
TF/M 327	86827033	3	5.05 /128.4	27	5.38/136.8	4.80/121.9	-
TF/M 330	86830033	3	5.05 /128.4	30	5.98/152.0	5.40/137.2	-
TF/M 333	86833033	3	5.05 /128.4	33	6.58/167.2	6.00/152.4	-
TF/M 336	86836033	3	5.05 /128.4	36	7.18/182.5	6.60/167.6	-
TF/M 339	86839033	3	5.05 /128.4	39	7.78/197.7	7.20/182.9	-
TF/M 342	86842033	3	5.05 /128.4	42	8.38/213.0	7.80/198.1	3.80/ 96.5
TF/M 345	86845033	3	5.05 /128.4	45	8.98/228.2	8.40/213.4	4.20/106.7
TF/M 348	86848033	3	5.05 /128.4	48	9.58/243.4	9.00/228.6	4.40/111.8
TF/M 4.506	86806453	4.5	7.68 /195.1	6	1.18/ 30.1	-	-
TF/M 4.509	86809453	4.5	7.68 /195.1	9	1.78/ 45.3	-	-
TF/M 4.512	86812453	4.5	7.68 /195.1	12	2.38/ 60.6	1.80/ 45.7	-
TF/M 4.515	86815453	4.5	7.68 /195.1	15	2.98/ 75.8	2.40/ 61.0	-
TF/M 4.518	86818453	4.5	7.68 /195.1	18	3.58/ 91.0	3.00/ 76.2	-
TF/M 4.521	86821453	4.5	7.68 /195.1	21	4.18/106.3	3.60/ 91.4	-
TF/M 4.524	86824453	4.5	7.68 /195.1	24	4.78/121.5	4.20/106.7	-
TF/M 4.527	86827453	4.5	7.68 /195.1	27	5.38/136.8	4.80/121.9	-
TF/M 4.530	86830453	4.5	7.68 /195.1	30	5.98/152.0	5.40/137.2	-
TF/M 4.533	86833453	4.5	7.68 /195.1	33	6.58/167.2	6.00/152.4	-
TF/M 4.536	86836453	4.5	7.68 /195.1	36	7.18/182.5	6.60/167.6	-
TF/M 4.539	86839453	4.5	7.68 /195.1	39	7.78/197.7	7.20/182.9	-
TF/M 4.542	86842453	4.5	7.68 / 95.1	42	8.38/213.0	7.80/198.1	3.80/ 96.5
TF/M 4.545	86845453	4.5	7.68 /195.1	45	8.98/228.2	8.40/213.4	4.20/106.7
TF/M 4.548	86848453	4.5	7.68 /195.1	48	9.58/243.4	9.00/228.6	4.40/111.8
TF/M 606	86806063	6	10.31/261.8	6	1.18/ 30.1	-	-
TF/M 609	86809063	6	10.31/261.8	9	1.78/ 45.3	-	-
TF/M 612	86812063	6	10.31/261.8	12	2.38/ 60.6	1.80/ 45.7	-
TF/M 615	86815063	6	10.31/261.8	15	2.98/ 75.8	2.40/ 61.0	-
TF/M 618	86818063	6	10.31/261.8	18	3.58/ 91.0	3.00/ 76.2	-
TF/M 621	86821063	6	10.31/261.8	21	4.18/106.3	3.60/ 91.4	-
TF/M 624	86824063	6	10.31/261.8	24	4.78/121.5	4.20/106.7	-
TF/M 627	86827063	6	10.31/261.8	27	5.38/136.8	4.80/121.9	-
TF/M 630	86830063	6	10.31/261.8	30	5.98/152.0	5.40/137.2	-
TF/M 633	86833063	6	10.31/261.8	33	6.58/167.2	6.00/152.4	-
TF/M 636	86836063	6	10.31/261.8	36	7.18/182.5	6.60/167.6	-
TF/M 639	86839063	6	10.31/261.8	39	7.78/197.7	7.20/182.9	-
TF/M 642	86842063	6	10.31/261.8	42	8.38/213.0	7.80/198.1	3.80/ 96.5
TF/M 645	86845063	6	10.31/261.8	45	8.98/228.2	8.40/213.4	4.20/106.7
TF/M 648	86848063	6	10.31/261.8	48	9.58/243.4	9.00/228.6	4.40/111.8

Botego Profile Sets

Page 5-48

BOTEGO Profile Set TF

A screwable front panel can be fitted to the enclosure by simply inserting TF profiles and tapped strips between the half-shells/extension sets. (2 pieces, 2 tapped strips).

- BO-PT1-06/68721060 Profile set TS, TE=6
- BO-PT1-09/68721090 Profile set TS, TE=9
- BO-PT1-12/68721120 Profile set TS, TE=12
- BO-PT1-15/68721150 Profile set TS, TE=15
- BO-PT1-18/68721180 Profile set TS, TE=18
- BO-PT1-21/68721210 Profile set TS, TE=21
- BO-PT1-24/68721240 Profile set TS, TE=24
- BO-PT1-27/68721270 Profile set TS, TE=27
- BO-PT1-30/68721300 Profile set TS, TE=30
- BO-PT1-33/68721330 Profile set TS, TE=33
- BO-PT1-36/68721360 Profile set TS, TE=36
- BO-PT1-39/68721390 Profile set TS, TE=39
- BO-PT1-42/68721420 Profile set TS, TE=42
- BO-PT1-45/68721450 Profile set TS, TE=45
- BO-PT1-48/68721480 Profile set TS, TE=48

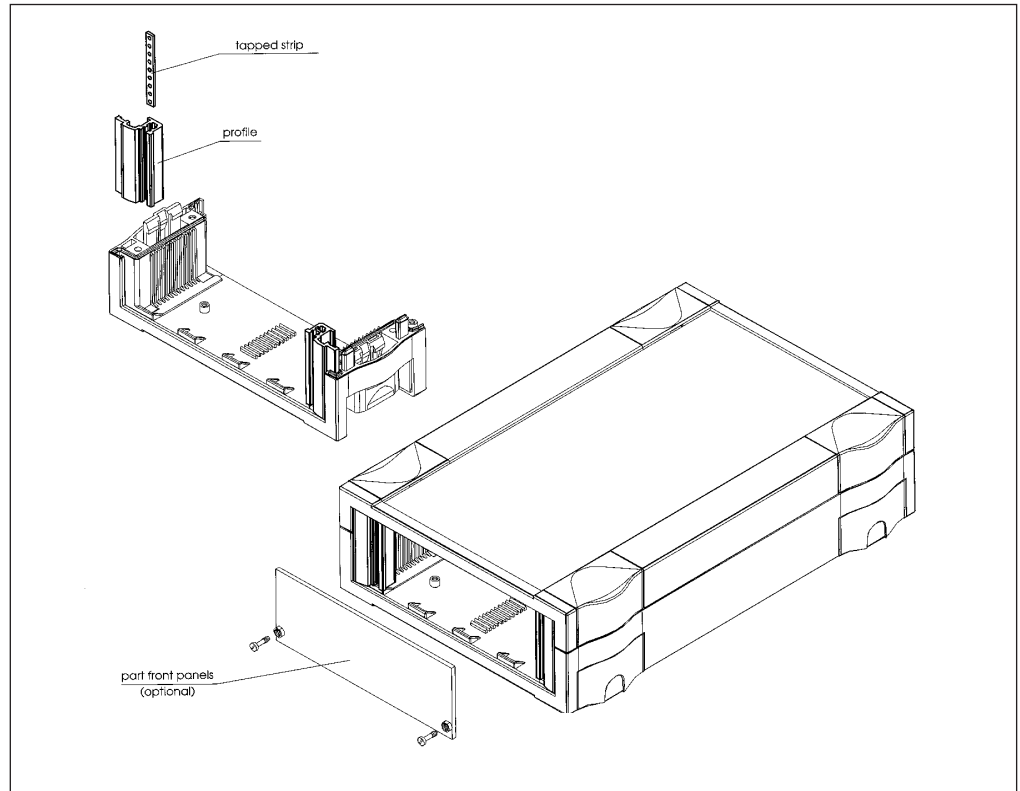

Botego Filling Profile Sets

Page 5-48

BOTEGO Filling Profile Set

Filling profile set for mounting racks. By shortening the flanges, any mounting rack can be inserted into the Botego enclosures. The empty areas above and under the mounting rack which are created by this process are closed by means of the filling profile set. (2 pieces).

- BO-PB1-21/68731210 Filling profile set for mounting racks TE 21. For BO 320 type.
- BO-PB1-42/38731420 Filling profile set for mounting racks TE 42. For BO 626 type.

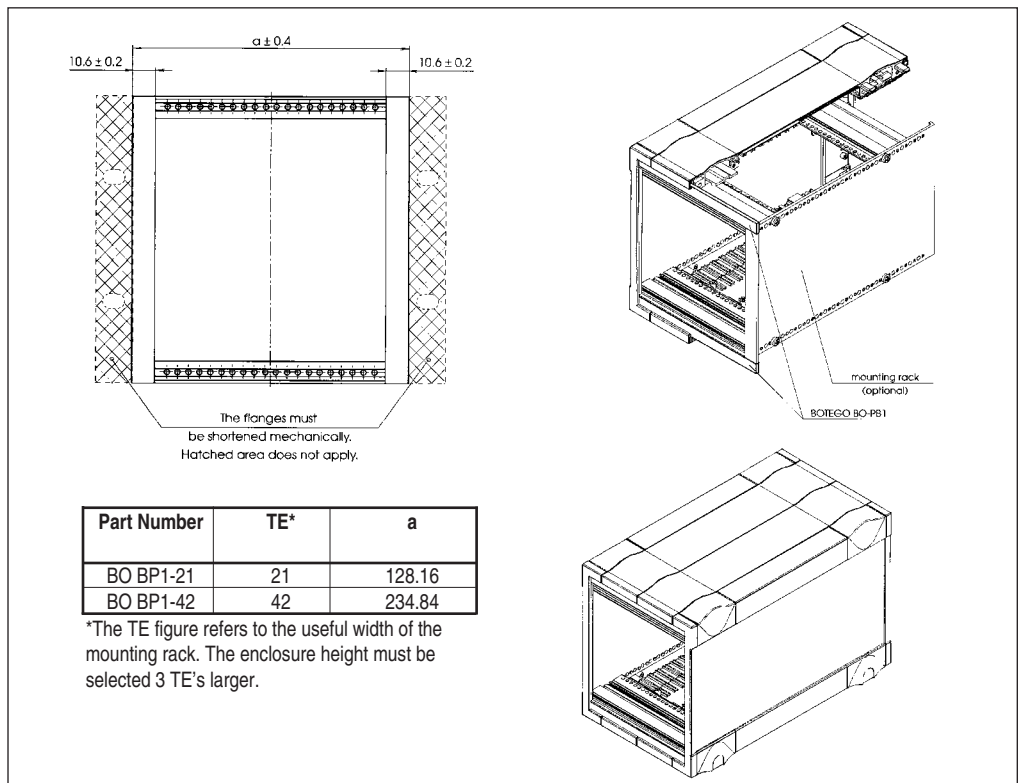

Dimensional Drawings

Accessories

Depending on the intended use of the enclosure, the handle can be fitted from the exterior to the side of the enclosure or to the enclosure foil surface. Because the handle swivels, in addition to its carrying function it can also be used to hold the enclosure at an angle (fixed locking position every 30°).

- BO HS 30000/68430000 Handle
- BO HS 50000/68450000 Handle
- BO HS 60000/68460000 Handle
- BO HS 00015/68400015 Handle, TE 15
- BO HS 00018/68400018 Handle, TE 18
- BO HS 00021/68400021 Handle, TE 21
- BO HS 00024/68400024 Handle, TE 24
- BO HS 00027/68400027 Handle, TE 27
- BO HS 00030/68400030 Handle, TE 30
- BO HS 00033/68400033 Handle, TE 33
- BO HS 00036/68400036 Handle, TE 36
- BO HS 00039/68400039 Handle, TE 39
- BO HS 00042/68400042 Handle, TE 42
- BO HS 00045/68400045 Handle, TE 45
- BO HS 00048/68400048 Handle, TE 48

Machining for BO HS 30000, 50000, 60000
half shell - low

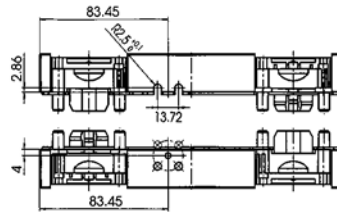

Machining for BO HS

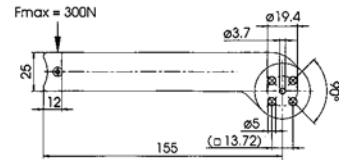

half shell high -

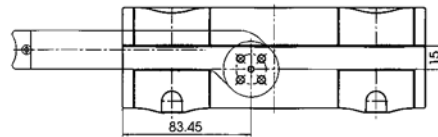

extension kit BO AB

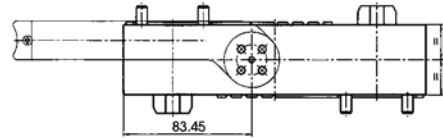

T1

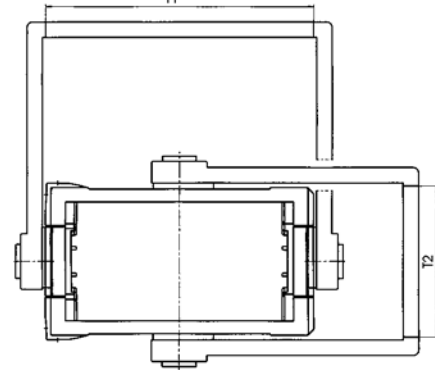

Machining for BO HS 000 . .

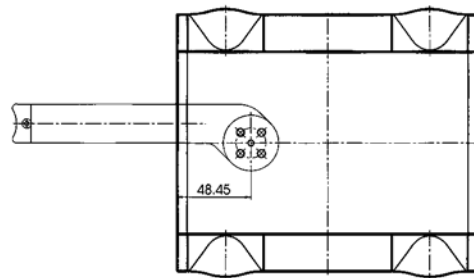

When used with enclosure BO 626... (L), in order to permit the handle to be swivelled onto the enclosure side, the handle must be mounted 20mm away from the middle of the enclosure.

Model Number	Part Number	TE	T1	T2	For Use With Enclosure
BO HS 30000	68430000	-	6.85 /174.0	-	BO 320... (L)
BO HS 50000	68450000	-	9.48 /240.7	-	BO 514... (L)
BO HS 60000	68460000	-	9.48 /240.7	-	BO 520... (L)
BO HS 00000	68460000	-	12.10/ 307.4	-	BO 626... (L)
BO HS 00015	68400015	15	-	3.85 /97.7	BO ...06 + 1 AB
BO HS 00018	68400018	18	-	4.44 /112.9	BO ...09 + 1 AB
BO HS 00021	68400021	21	-	5.05 /128.2	BO ...12 + 1 AB
BO HS 00024	68400024	24	-	5.64 /143.4	BO ...06 + 2 AB
BO HS 00027	68400027	27	-	6.25 /158.6	BO ...09 + 2 AB
BO HS 00030	68400030	30	-	6.85 /173.9	BO ...12 + 2 AB
BO HS 00033	68400033	33	-	7.44 /189.1	BO ...06 + 3 AB
BO HS 00036	68400036	36	-	8.04 /204.4	BO ...09 + 3 AB
BO HS 00039	68400039	39	-	8.64 /219.6	BO ...12 + 3 AB
BO HS 00042	68400042	42	-	9.24 /234.8	BO ...06 + 4 AB
BO HS 00045	68400045	45	-	9.85 /250.1	BO ...09 + 4 AB
BO HS 00048	68400048	48	-	10.44/ 265.3	BO ...12 + 4 AB